

# fineline™ track ~ Fixing Instructions ~

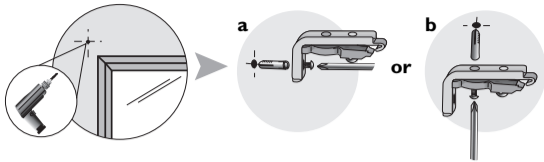

- 1** Decide on wall fix (a) or top fix (b).  
Mark and drill a small hole in the desired positions for supports.  
Insert wall plugs and fix the support securely in position.

## CUTTING TO SIZE

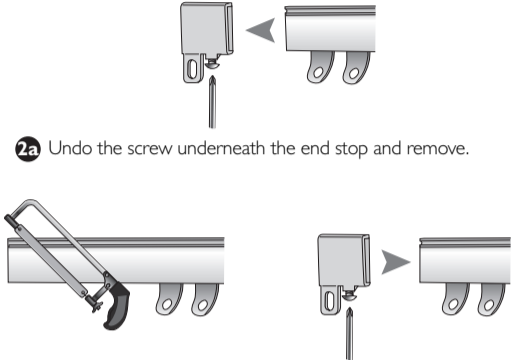

- 2a** Undo the screw underneath the end stop and remove.
- 2b** Cut to the required length and replace the end stop.  
*On 2 piece tracks, please ensure you cut an equal amount off both pieces of track. This will ensure the join remains in the centre of your window.*

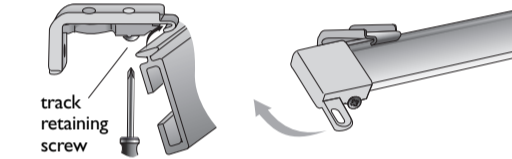

- 3** Loosen the track retaining screw & present the track to the support at approximately a 30° angle, and clip the top channel under the front lip on the support.
- Rotate the track to a vertical position to clip securely into place.  
Tighten the track retaining screw to secure.

## HOW TO JOIN LONGER LENGTHS

*Longer lengths are achieved on 250/300/350/400cm track by joining 2 sets of track using a joining bar.*

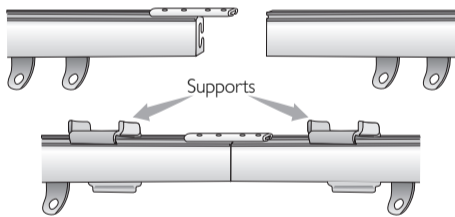

N.B. For strength on longer track, position 1 support either side of the joining bar; this will provide extra stability.

## HOW TO BEND

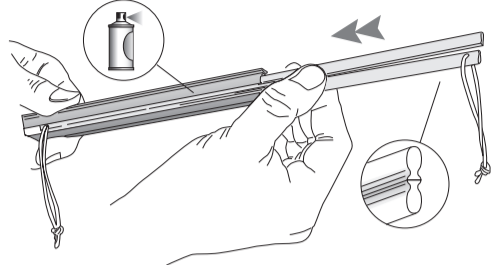

- 4a** Lightly spray the inside of the track with silicon or furniture polish. Slide both the bending inserts into the track channel ensuring the flat edges are positioned together and the cords are at opposite ends as shown.

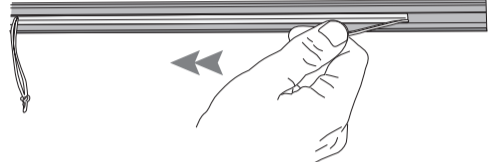

- 4b** Using the strings, pull the 2 bending inserts to the centre of the position you wish to bend the track.

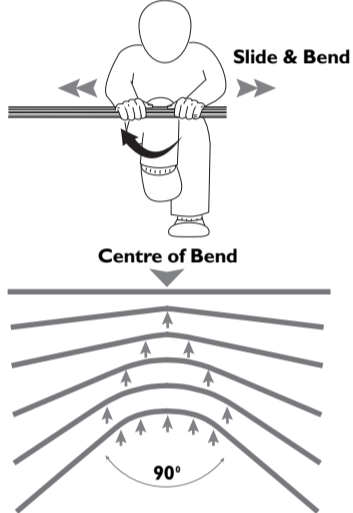

- 4c** Firmly bend the track in your desired position by applying pressure and **Slightly bending and moving** the track forming a number of slight bends along the track as above until the desired angle is reached.  
Practical Tip: Place a cloth around your knee to prevent injury or damage to your clothes.

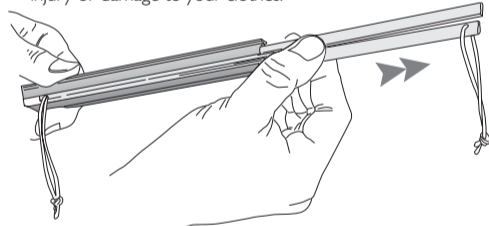

- 4d** Remove the bending inserts and hang track.

## DOUBLE SUPPORTS - available as an accessory

**Extension used for a single track**  
e.g. to hang over window sill or radiator

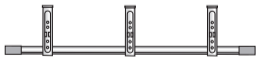

can be bent to form a return, also ideal for use as a **valance rail**

### FINELINE DOUBLE SUPPORT

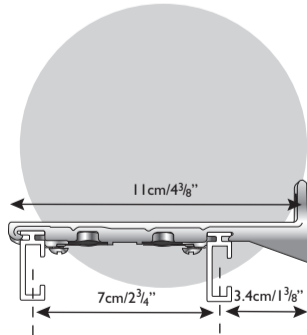

**Extension used to form a double track**

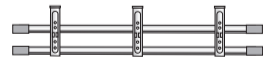

**Extension used to form a track & valance rail or layered curtain**

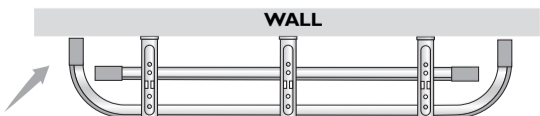

For layered curtains the outside curtain can be returned to the wall for a neater finish

For further information visit: [www.finelinetrack.co.uk](http://www.finelinetrack.co.uk)